

# GU LINE



Innesti Rapidi  
Couplings  
Coupleurs  
Kupplungen



GU 21	Innesto rapido DN5	Coupler DN5	Coupleur DN5	Kupplung DN5	
1	2	3	4	5	
Corpo Body Corps Körper	Otturatore Valve Clapet Ventil	Molle Springs Ressorts Feder	Guarnizioni Seals Joint d'étanchéité Dichtung	Sfere Balls Billes Kugel	Innesti Plugs Embouts Stecker
Ottone UNI EN 12164 CW614N Nichelato Brass UNI EN 12164 CW614N Nickel plated Laiton UNI EN 12164 CW614N Nickelé Ms Vernickelt UNI EN 12164 CW614N	Ottone UNI EN 12164 CW614N Nichelato Brass UNI EN 12164 CW614N Nickel plated Laiton UNI EN 12164 CW614N Nickelé Ms Vernickelt UNI EN 12164 CW614N	Acciaio Inox AISI 302 Stainless Steel AISI 302 Acier Inox AISI 302 Edelstahl AISI 302	NBR NBR NBR	Acciaio Inox AISI 420 Stainless Steel AISI 420 Acier Inox AISI 420 Edelstahl AISI 420	Ottone UNI EN 12164 CW614N Nichelato Brass UNI EN 12164 CW614N Nickel plated Laiton UNI EN 12164 CW614N Nickelé Ms Vernickelt UNI EN 12164 CW614N

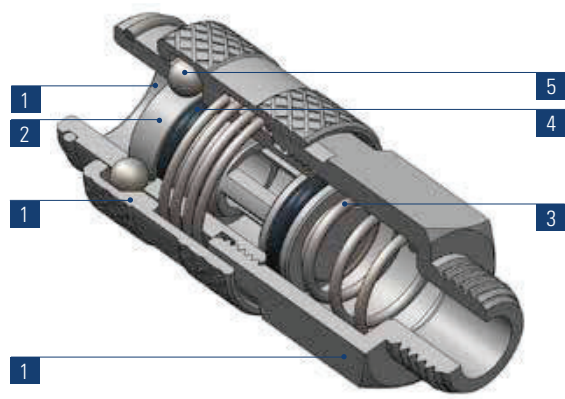

Campi di applicazione:  
Impianti pneumatici.

Application fields:  
Pneumatic circuits.

Domaines d'application:  
Circuits pneumatiques.

Anwendungsbereiche:  
Pneumatische Anlagen.

### GU 21-11

Innesto rapido con filetto maschio

Male coupling

Coupleur mâle

Einschraubkupplung

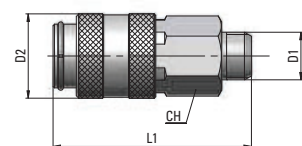

Tipo	D1	D2	L1	CH	g ΔΔ
<b>11 00 18</b>	<b>G1/8</b>	16	40	14	27
<b>11 00 14</b>	<b>G1/4</b>	16	40	17	37

### GU 21-12

Innesto rapido con filetto femmina

Female coupling

Coupleur femelle

Aufschraubkupplung

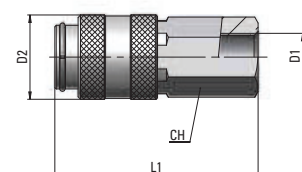

Tipo	D1	D2	L1	CH	g ΔΔ
<b>12 00 18</b>	<b>G1/8</b>	16	40	14	35
<b>12 00 14</b>	<b>G1/4</b>	16	41	17	44,5

**GU 21-13**

Innesto rapido con portagomma

Coupling with hose connection

Coupleur avec douille cannelée

Kupplung mit Schlauchtülle

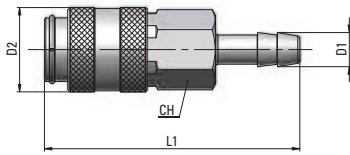

Tipo	Øi Tubo	D1	D2	L1	CH	g $\Delta$
<b>13 04 00</b>	<b>4</b>	5	16	50	14	25
<b>13 06 00</b>	<b>6</b>	7	16	50	14	32

**GU 21-15**

Innesto rapido con calzamento

Coupling with Nut fitting

Coupleur avec raccord à écrou

Kupplung mit Überwurfverschraubung

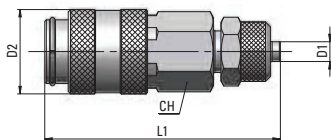

Tipo	D1	D2	L1	CH	g $\Delta$
<b>15 06 00</b>	<b>6x4</b>	16	47	14	37
<b>15 08 00</b>	<b>8x6</b>	16	48	14	38

**GU 21-20**

Innesto con filetto maschio

Male plug

Embout mâle

Einschraubverschlußnippel

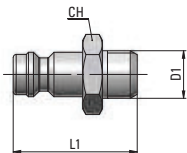

Tipo	D1	L1	CH	g $\Delta$
<b>20 00 18</b>	<b>G1/8</b>	25	14	11
<b>20 00 14</b>	<b>G1/4</b>	27	17	19

**GU 21-21**

Innesto con filetto femmina

Female plug

Embout femelle

Aufschraubverschlußnippel

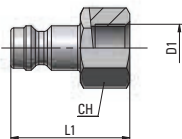

Tipo	D1	L1	CH	g $\Delta$
<b>21 00 18</b>	<b>G1/8</b>	25	14	13
<b>21 00 14</b>	<b>G1/4</b>	27	17	19

**GU 21-22**

Innesto con portagomma

Plug with hose connection

Embout avec douille cannelée

Schlauchtülle

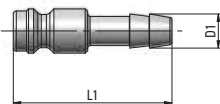

Tipo	Øi Tubo	D1	L1	g $\Delta$
<b>22 04 00</b>	<b>4</b>	5	32	6
<b>22 06 00</b>	<b>6</b>	7	32	6,5

**GU 21-23**

Innesto con raccordo a calzamento

Plug with Nut Fitting

Embout avec raccord à écrou

Verschlußstülle mit Überwurfmutter

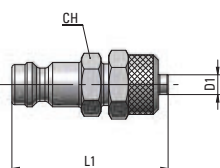

Tipo	D1	L1	CH	g $\Delta$
<b>23 06 00</b>	<b>6x4</b>	32	11	15
<b>23 08 00</b>	<b>8x6</b>	33	13	18

**GU 21-24**

Innesto con molla di protezione

Plug with hose protection spring

Embout avec ressort protection tube

Verschlussstülle mit Knickschutzfeder

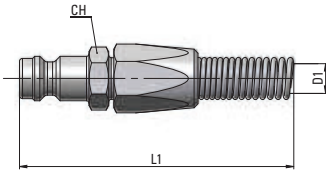

Tipo	D1	L1	CH	g $\Delta$
<b>24 06 00</b>	<b>6x4</b>	110	11	24
<b>24 08 00</b>	<b>8x6</b>	120	13	31