

MAF302 series

AIR UNIT (FILTER)

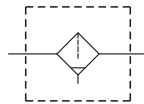

Symbol



Specification

Model	MAF302		
Bore No.	8A	10A	15A
Port size	1/4	3/8	1/2
Medium	Air		
Operating pressure range (*)	0.05~1 MPa		
Proof pressure	1.5 MPa		
Ambient temperature	- 5~+60°C (No freezing)		
Filter element	Standard: 5μm, Option: 40μm		
Drain capacity	35 cm ³		
Weight	335 g		

* Standard unit contains semi-auto-drain function when operating pressure below 0.05 MPa.

* Choose auto-drain FMRF300, the pressure range is 0.15~1 MPa.

Order example

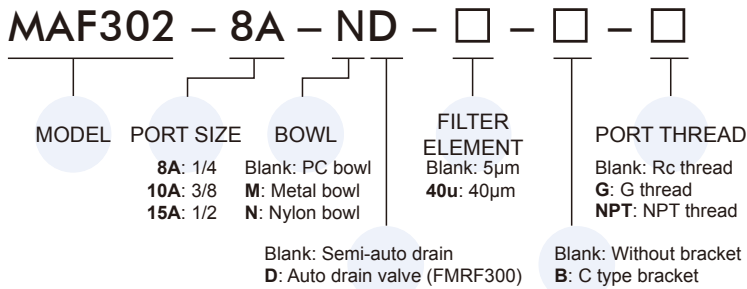

Flow feature

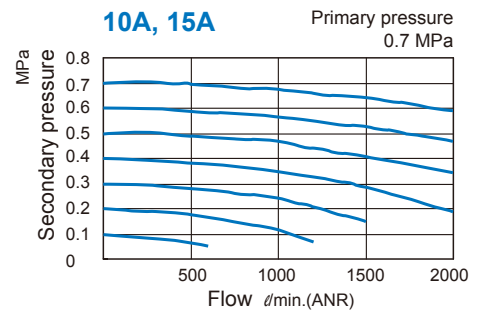
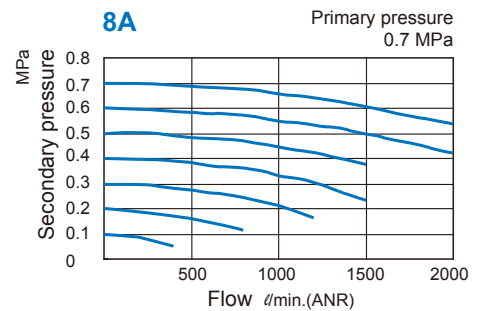

Option accessories

C type bracket

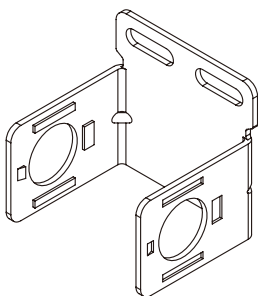

Caution

Metal bowl

Before assembling or disassembling, push the lock plate down to the end, and confirm that it is detached from the body then rotate the bowl, otherwise the lock plate will be deformed or the body will be scratched.

1. Sliding plate down
2. Rotating the bowl

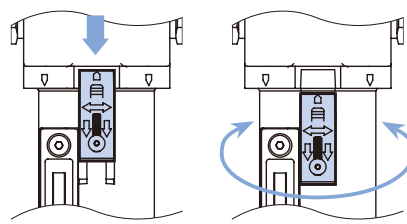

MAF302 Dimensions

AIR UNIT (FILTER)

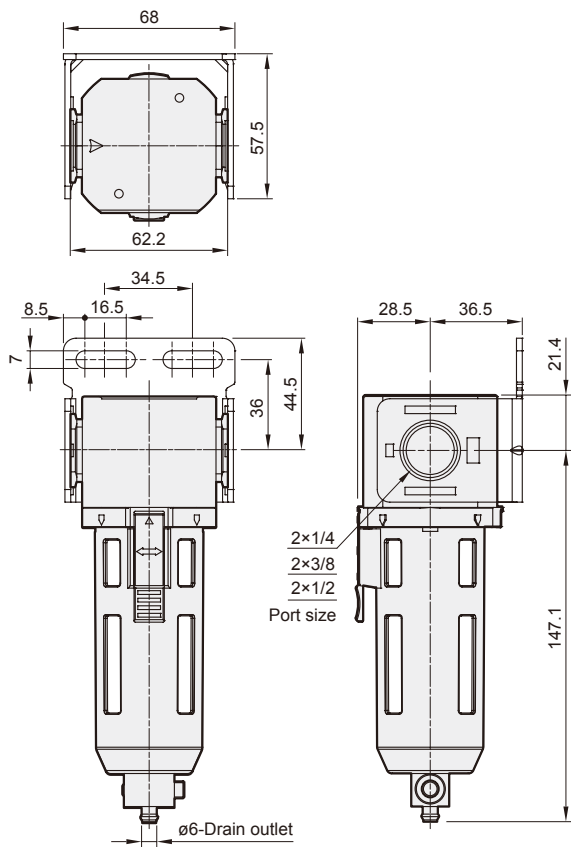

MAF302-D

Auto drain valve

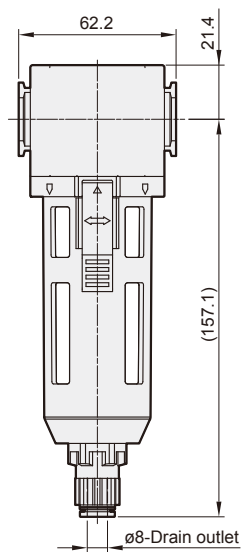

MAF302-M

Metal bowl

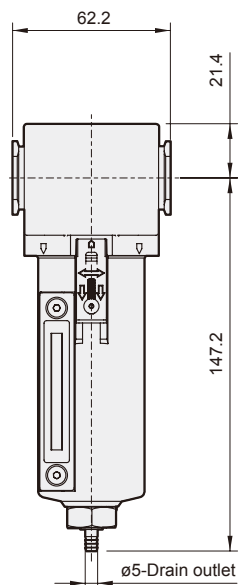

MAF302-MD

Metal bowl + Auto drain valve

