



ITT Enidine's **New ECO Series** non-adjustable hydraulic shock absorbers can accommodate varying energy conditions. This family of tamperproof shock absorbers provides consistent performance, cycle after cycle. Non-adjustable models are designed to absorb maximum energy within a compact envelope size.

The **ECO Series** was designed using materials and fluids that are safe for our environment. Models can accommodate a wide range of operating conditions with varying masses or propelling forces. The **ECO Series** offers a flexible design to accommodate a wide variety of application parameters. Whether your application has a low velocity/high drive force or high velocity/low drive force condition, the **New ECO Series** will deliver the performance that you have come to expect.

## Features and Benefits

- **Extensive non-adjustable product line** offers flexibility in both size and energy absorption capacity to fulfill a wide range of application requirements.
- **Environmentally friendly materials:**
  - RoHS Compliant materials
  - Bio-degradable hydraulic oil
  - Copper-Free design
  - Recyclable packaging materials
- **Introducing our new Enicote II surface finish:**
  - RoHS Compliant
  - Rated at 350 hours salt spray corrosion protection
- **Jam Nut included** with every shock absorber.
- **ISO quality standards** result in reliable, long-life operation.
- **Tamperproof design** ensures repeatable performance.
- **Threaded cylinders provide mounting flexibility** and increase surface area for improved heat dissipation.
- **Wrench flats** promote ease of mounting
- **Capability to mount into pressure chambers**
- **Integrated positive stopping capabilities** up to 100 psi (7 bar).
- **Special materials and finishes** can be designed to meet specific customer requirements
  - Optional fluids and seal packages can expand the standard operating temperature range from (15°F to 180°F) to (-30°F to 210°F)
  - Food grade options available
- **Custom orificed (CBECO)** can be engineered to meet specific application requirements or emergency impact only requirements.

## ITT Enidine Non-Adjustable Multiple Orifice Shock Absorbers

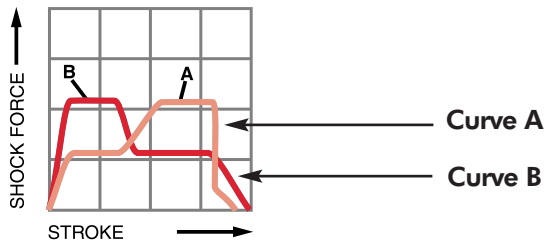
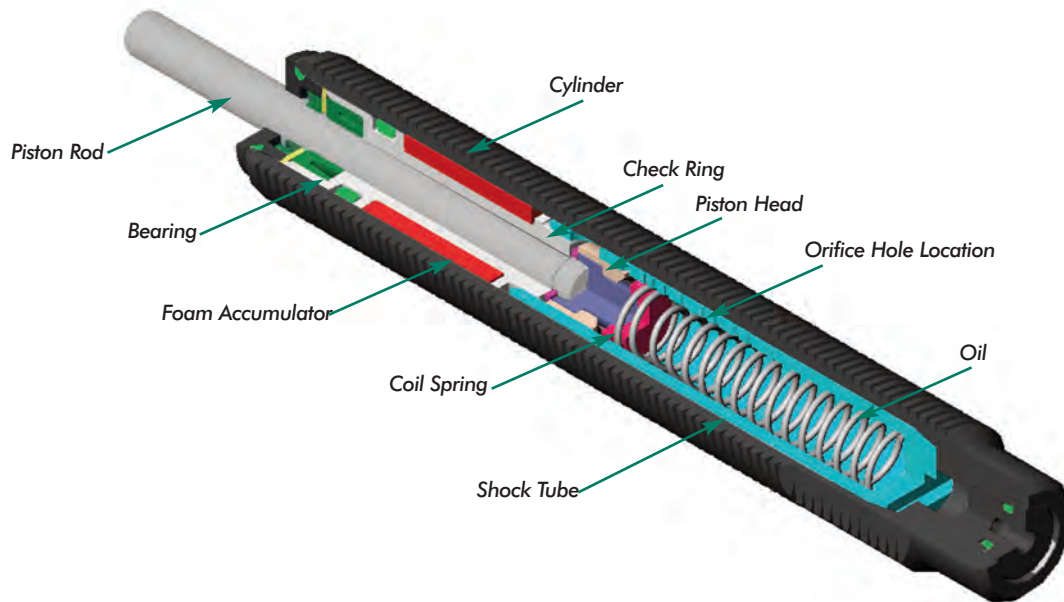

**Self-compensating damping** maintains acceptable deceleration with conventional type damping characteristics. Self-compensating shock absorbers operate over a wide range of weights and velocities. These shock absorbers are well suited for high drive force, low velocity applications, and where energy conditions may change. **Curve A** shows the *shock force vs. stroke* curve of a self-compensating shock absorber impacted with a low velocity and high drive force. **Curve B** shows the *shock force vs. stroke* curve of a self-compensating shock absorber impacted with a high velocity and low drive force.

The design of a multi-orifice shock absorber features a double cylinder arrangement with space between the concentric shock tube and cylinder, and a series of orifice holes drilled down the length of the shock tube wall.

During piston movement, the check ring is seated and oil is forced through the orifices in the shock tube wall, into the closed cellular foam accumulator and behind the piston head.

As the piston head moves it closes off orifice holes, thus reducing the available orifice area in proportion to the velocity. After the load is removed the coil spring pushes the piston rod outward. This unseats the check ring and permits the oil to flow from the accumulator and across the piston head, back into the shock tube. This allows quick repositioning for the next impact.

Low Pressure multiple orifice shock absorbers can provide progressive or self-compensating damping, depending on the impact conditions.

Standard

ECO 8 → ECO 100 Series

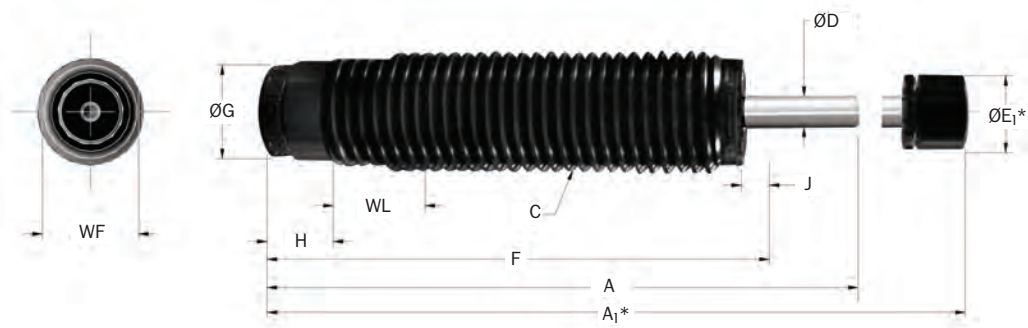

\*Note: A1 and E1 apply to button models and urethane striker cap accessory. One Hex Jam Nut included with every shock absorber.

Catalog No./ Model	(S) Stroke in. (mm)	(E <sub>T</sub> ) Max. in.-lbs./cycle (Nm/cycle)	(E <sub>T</sub> E) Emergency Max. in.-lbs./cycle (Nm/cycle)	(E <sub>T</sub> C) Max. in.-lbs./hour (Nm/h)	(F <sub>p</sub> ) Max. Reaction Force lbs. (N)	Nominal Coil Spring Force		(F <sub>D</sub> ) Max. Propelling Force lbs. (N)	Model Weight oz. (g)
						Extended lbs. (N)	Compressed lbs. (N)		
ECO 8 (B)	0.25 (6,4)	35 (4,0)	—	55,000 (6 215)	200 (890)	0.6 (2,7)	1.2 (5,6)	45 (200)	.5 (16)
ECO 10 (B)	0.28 (7,0)	62 (7,0)	—	120,700 (13 640)	360 (1 600)	0.5 (2,2)	1.0 (4,5)	80 (350)	1.0 (28)
ECO 15 (B)	0.41 (10,4)	106 (12,0)	220 (25)	275,000 (31 020)	450 (2 000)	0.7 (3,0)	1.6 (7,0)	50 (220)	2.0 (56)
ECO S 25 (B)	0.50 (12,7)	212 (24,0)	390 (44)	331,000 (37 400)	625 (2 800)	1.0 (4,5)	2.5 (11,0)	200 (890)	2.4 (68)
ECO 25 (B)	0.63 (16,0)	265 (30,0)	500 (56)	389,000 (44 000)	625 (2 800)	1.0 (4,5)	2.5 (11,0)	200 (890)	2.4 (68)
ECO S 50 (B)	0.50 (12,7)	285 (32,0)	560 (63)	440,000 (49 720)	850 (3 750)	1.5 (6,0)	3.5 (15,0)	360 (1 600)	3.0 (69)
ECO 50 (B)	0.88 (22,0)	550 (62,0)	975 (110)	523,000 (59 070)	850 (3 750)	2.0 (8,9)	6.8 (30,0)	360 (1 600)	4.8 (136)
ECO 100 (B)	1.00 (25,0)	930 (105,0)	2210 (250)	681,500 (77 000)	1,250 (5 500)	3.0 (13,0)	6.0 (27,0)	500 (2 200)	10.5 (297)

\*Notes: Maximum energy rating for emergency use only. Estimated cycle life of 1-5 cycles if used at maximum emergency rating.

Catalog No./ Model	Damping Constant	A in. (mm)	A <sub>1</sub> in. (mm)	C in. (mm)	D in. (mm)	E <sub>1</sub> in. (mm)	F in. (mm)	G in. (mm)	H in. (mm)	J in. (mm)	WF in. (mm)	WL in. (mm)
ECO 8 IF (B)	-1,-2,-3	1.86 (47,0)	2.25 (57,0)	3/8 - 32 UNEF	.10 (2,5)	0.27 (6,8)	1.61 (40,9)	.26 (6,6)	.18 (4,6)	.10 (2,5)	—	—
ECO 8 MF (B)	-1,-2,-3	—	—	M8 x 0,75	—	—	—	—	—	—	—	—
ECO 8 MC (B)	-1,-2,-3	—	—	M8 x 1,0	—	—	—	—	—	—	—	—
ECO 10 IF (B)	-1,-2,-3	2.12 (54,0)	2.51 (64,0)	7/16 - 28 UNEF	.12 (3,0)	0.34 (8,6)	1.83 (46,5)	.34 (8,6)	.18 (4,6)	.13 (3,3)	—	—
ECO 10 MF (B)	-1,-2,-3	—	—	M10 x 1,0	—	—	—	—	—	—	—	—
ECO 15 IF (B)	-1,-2,-3,-4	2.45 (62,2)	2.85 (72,4)	7/16 - 28 UNEF	.12 (3,0)	.40 (10,2)	2.10 (52,1)	.39 (9,9)	.27 (6,9)	.10 (2,5)	.39 (11,0)	.38 (9,5)
ECO 15 MF (B)	-1,-2,-3,-4	—	—	M12 x 1,0	—	—	—	—	—	—	—	—
ECO 15 IC (B)	-1,-2,-3,-4	—	—	1/2 - 20 UNEF	—	—	—	—	—	—	—	—
ECO S 25 MF (B)	-1,-2,-3	3.25 (82,7)	3.63 (92,2)	M14 x 1,0	.16 (4,0)	0.44 (11,2)	2.74 (69,5)	.43 (10,9)	.20 (5,1)	.04 (1,0)	(12,0)	.50 (12,7)
ECO S 25 IC (B)	-1,-2,-3	—	—	3/16 - 18 UNF	—	—	—	—	—	—	.50 (12,7)	(12,0)
ECO S 25 MC (B)	-1,-2,-3	—	—	M14 x 1,5	—	—	—	—	—	—	—	(12,0)
ECO 25 IF (B)	-1,-2,-3,-4	—	—	1/2 - 20 UNF	—	—	—	—	—	—	—	.44 (11,2)
ECO 25 MF (B)	-1,-2,-3,-4	3.84 (97,5)	4.22 (107,2)	M14 x 1,0	.16 (4,0)	.44 (11,2)	3.20 (81,3)	.43 (10,9)	.30 (7,6)	.04 (1,0)	(12,0)	.50 (12,7)
ECO 25 IC (B)	-1,-2,-3,-4	—	—	3/16 - 18 UNF	—	—	—	—	—	—	.50 (12,7)	(12,0)
ECO 25 MC (B)	-1,-2,-3,-4	—	—	M14 x 1,5	—	—	—	—	—	—	—	(12,0)
ECO S 50 IF (B)	-1,-2,-3	3.46 (87,9)	3.93 (99,9)	3/4 - 16 UNF	.19 (4,8)	0.50 (12,7)	2.93 (74,4)	.64 (16,3)	.30 (7,6)	.04 (1,0)	.68 (18,0)	.50 (12,7)
ECO S 50 MC (B)	-1,-2,-3	—	—	M20 x 1,5	—	—	—	—	—	—	(18,0)	(12,7)
ECO 50 IF (B)	-1,-2,-3,-4	4.66 (118,4)	5.13 (130,3)	3/4 - 16 UNF	.19 (4,8)	0.50 (12,7)	3.76 (95,5)	.64 (16,3)	.30 (7,6)	.04 (1,0)	.68 (18,0)	.50 (12,7)
ECO 50 MC (B)	-1,-2,-3,-4	—	—	M20 x 1,5	—	—	—	—	—	—	(18,0)	(12,7)
ECO 100 IF (B)	-1,-2,-3,-4	5.07 (128,8)	5.57 (141,5)	1-12 UNF	.25 (6,4)	0.62 (15,7)	4.04 (102,6)	.87 (22,0)	.50 (12,7)	.18 (4,6)	.88 (23,0)	.50 (12,7)
ECO 100 MF (B)	-1,-2,-3,-4	—	—	M25 x 1,5	—	—	—	—	—	—	.88 (23,0)	(12,7)
ECO 100 MC (B)	-1,-2,-3,-4	—	—	M27 x 3,0	—	—	—	—	—	—	—	(12,7)

Notes: 1. See page 54 for constant damping curves.

# Non-Adjustable Series Hydraulic Shock Absorbers

## ECO Series

### Accessories

ECO 8 → ECO 100 Series

### Jam Nut (JN)

\*Note: One Hex Jam Nut included with every shock absorber.

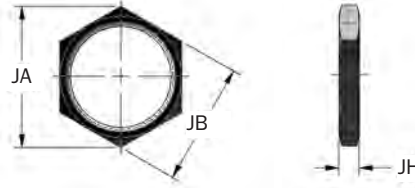

Catalog No./ Model	ECO Series Part Number	Model (Ref)	JA in. (mm)	JB in. (mm)	JH in. (mm)	Weight (mass) oz. (g)
JN 3/8 - 32	J123839034	ECO 8 (B)	0.58	0.50	.09	0.1
JN M8 x 0,75	J223839185	ECO 8 MF (B)	(14,0)	(12,0)	(4,0)	(2)
JN M8 x 1	J223839035	ECO 8 MC (B)	(14,0)	(12,0)	(4,0)	(2)
JN 7/16 - 28	J123840034	ECO 10 IF (B)/ECO 15 (B)	0.65	0.56	.16	0.1
JN M10 x 1	J223840167	ECO 10 MF (B)	(17,3)	(15,0)	(4,0)	(2)
JN M12 x 1	J223841035	ECO 15 M (B)	(15,0)	(13,0)	(3,2)	(2)
JN 1/2 - 20	J123842166	ECO 25 IF (B)	0.72	0.63	.12	0.1
JN M14 x 1	J223842035	ECO S/ECO 25 MF (B)	(19,7)	(17,0)	(4,0)	(3)
JN 9/16 - 18	J123842034	ECO S/ECO 25 IC (B)	1.01	0.88	.31	0.6
JN M14 x 1,5	J223842165	ECO S/ECO 25 MC (B)	(19,7)	(17,0)	(4,0)	(3)
JN 3/4 - 16	J123844034	ECO S/ECO 50 IC (B)	1.08	0.94	.18	0.3
JN M20 x 1,5	J223844035	ECO S/ECO 50 MC (B)	(27,7)	(24,0)	(4,6)	(7)
JN 1-12	J123846034	ECO 100 (B)	1.30	1.13	.18	0.5
JN M25 x 1,5	J223846035	ECO 100 MF (B)	(37,0)	(32,0)	(4,6)	(15)

### Stop Collar (SC)

ECO8 → ECO100

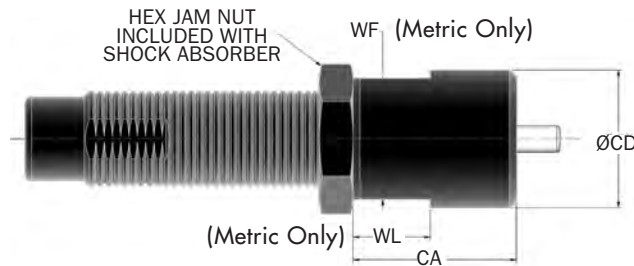

Catalog No./ Model	ECO Series Part Number	Model (Ref)	CA in. (mm)	CB in. (mm)	CD in. (mm)	WF in. (mm)	WL in. (mm)	Weight (mass) oz. (g)
SC 3/8 - 32	M923839057	ECO 8 (B)	0.75	.50	0.58	-	-	.5
SC M8 x 0,75	M923839175	ECO 8 MF (B)	(19,0)	(12,0)	(14,0)	-	-	(23)
SC M8 x 1	M923839058	ECO 8 MC (B)	(19,0)	(12,0)	(14,0)	-	-	(23)
SC 7/16 - 28	M923841057	ECO 10 IF (B)	0.75	-	0.63	-	-	.5
SC M10 x 1	M923840171	ECO 10 MF (B)	(19,0)	-	(14,0)	-	-	(11)
SC 7/16 - 28	M923841057	ECO 15 (B)	0.75	-	0.63	-	-	.5
SC M12 x 1	M923841058	ECO 15 M (B)	(19,0)	-	(16,0)	(14,0)	(9,0)	(14)
SC 1/2 - 20	M923842057	ECO 25 IF (B)	1.00	-	0.75	-	-	1.0
SC M14 x 1,5	M923842171	ECO S/ECO 25 MF (B)	(25,4)	-	(21,0)	(19,0)	(12,0)	(38)
SC 9/16 - 18	M923842199	ECO S/ECO 25 IC (B)	1.00	-	0.69	-	-	1.0
SC M14 x 1	M923842058	ECO S/ECO 25 MF (B)	(25,4)	-	(19,0)	(17,0)	(12,0)	(20)
SC 3/4 - 16	M923844057	ECO S/ECO 50 (B)	1.50	-	1.00	-	-	2.0
SC M20 x 1,5	M924057058	ECO S/ECO 50 M (B)	(38,0)	-	(25,0)	(22,0)	(12,0)	(63)
SC 1-12 x 1	M923846057	ECO 100 (B)	1.75	-	1.50	-	-	8.0
SC M25 x 1,5	M923846171	ECO 100 MF (B)	(44,5)	-	(38,0)	(32,0)	(15,0)	(215)

Non-Adjustable Series

ECO 8 → ECO 100 Series

### Side Load Adaptor (SLA)

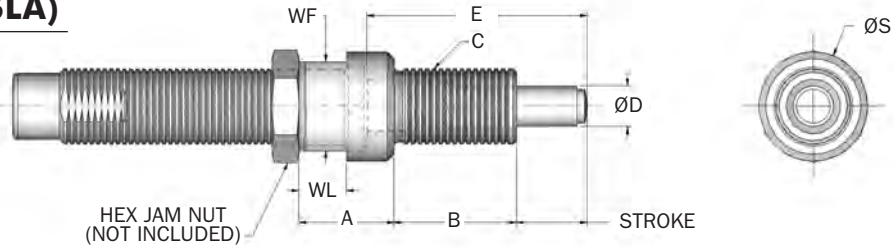

Catalog No./ Model	ECO Series Part Number	Model (Ref)	Stroke in. (mm)	A in. (mm)	B in. (mm)	C in. (mm)	D in. (mm)	E in. (mm)	S in. (mm)	WF in. (mm)	WL in. (mm)
SLA 1/16 - 28 x .28	SLA 33974	ECO 10	.28 (6,4)	.43 (11)	.47 (12)	7/16-28 UNEF	.20 (5,0)	.87 (21,9)	.63 (13,0)	.56 (11,0)	.16 (4,0)
SLA 10 MF	SLA 33457	ECO 10 MF				M10 x 1					
SLA 1/16 - 28 x .41	SLA 33844	ECO 15 IF	.41 (10,0)	.55 (14)	.71 (18)	7/16-28 UNEF	.24 (6,0)	1.28 (32,4)	.63 (14,0)	.56 (13,0)	.28 (7,0)
SLA 12 MF	SLA 33299	ECO 15 MF				M12 x 1					
SLA 1/2 - 20 x .41	SLA 71146	ECO 15 IC	.41 (10,0)	.55 (14)	.71 (18)	1/2-20 UNF	.24 (6,0)	1.28 (32,4)	.63 (14,0)	.56 (13,0)	.28 (7,0)
SLA 1/2 - 20 x .63	SLA 33849	ECO 25 IF	.63 (16,0)	.51 (13)	1.02 (26)	1/2-20 UNF	.31 (8,0)	1.62 (41,5)	.71 (18,0)	.63 (15,0)	.28 (7,0)
SLA 14 MF	SLA 33297	ECO 25 MF				M14 x 1					
SLA 1/16 - 18 x .63	SLA 33850	ECO 25 IC	.63 (16,0)	.51 (13)	1.02 (26)	9/16-18 UNF	.31 (8,0)	1.62 (41,5)	.71 (18,0)	.63 (15,0)	.28 (7,0)
SLA 14 MC	SLA 33298	ECO 25 MC				M14 x 1,5					
SLA 14 MFS	SLA 33306	ECO S 25 MF				M14 x 1					
SLA 1/16 - 18 x .50	SLA 33846	ECO S 25 IC	.5 (12,7)	.63 (16)	.79 (20)	9/16-18 UNF	.31 (8,0)	1.55 (39,2)	.71 (18,0)	.63 (15,0)	.28 (7,0)
SLA 14 MCS	SLA 33301	ECO S 25 MC				M14 x 1,5					
SLA 3/4 - 16 x .88	SLA 33851	ECO 50	.88 (22,0)	.67 (17)	1.26 (32)	3/4-16 UNF	.43 (11,0)	2.44 (62,0)	.98 (25,0)	.88 (22,0)	.28 (7,0)
SLA 20 MC	SLA 33302	ECO 50 M				M20 x 1,5					
SLA 3/4 - 16 x .50	SLA 33847	ECO S 50	.5 (12,7)	.55 (14)	.94 (24)	3/4-16 UNF	.43 (11,0)	1.64 (41,5)	.98 (25,0)	.88 (22,0)	.28 (7,0)
SLA 20 MCS	SLA 33262	ECO S 50 M				M20 x 1,5					
SLA 1-12 x 1	SLA 33848	ECO 100	1.00 (25,4)	1.18 (30)	1.50 (38)	1-12 UNF	.59 (15,0)	2.88 (73,2)	1.42 (36,0)	1.25 (32,0)	.39 (10,0)
SLA 25 MF	SLA 33263	ECO 100 MF				M25 x 1,5					
SLA 25 MC	SLA 33296	ECO 100 MC				M27 x 3					

Notes: 1. Maximum sideload angle is 30°. 2. Part numbers in page color are non-standard lead time items, contact Enidine.

### Universal Retaining Flange (UF)

UF 3/8 - 32 → UF 1/2 - 20  
UF M10 x 1 → UF M14 x 1,5

UF 1/16 - 18 → UF 3/4 - 16  
UF M20 x 1,5 → UF M27 x 3

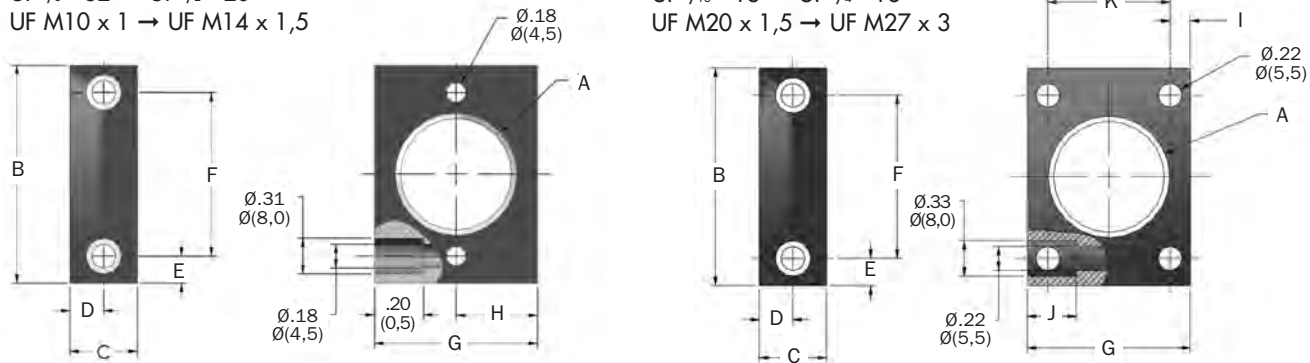

Catalog No./ Model	ECO Series Part Number	Model (Ref)	A in. (mm)	B in. (mm)	C in. (mm)	D in. (mm)	E in. (mm)	F in. (mm)	G in. (mm)	H in. (mm)	I in. (mm)	J in. (mm)	K in. (mm)
UF M10 x 1	U16363189	ECO 10M	M10 x 1 (38,0)	(12,0)	(6,0)	(6,25)	(25,5)	(25,0)	(12,5)	—	(5,0)	—	—
UF 7/16 - 28	U15588095	ECO 15 (B)/ECO 10 (B)	7/16 - 28 UNF	1.50	.56	.28	.25	1.00	1.00	0.50	—	.20	—
UF M12 x 1	U15588189	ECO 15 M (B)	M12 x 1 (38,0)	(12,0)	(6,0)	(6,25)	(25,5)	(25,0)	(12,5)	—	(5,0)	—	—
UF 1/2 - 20	U13935095	ECO 25 IF (B)	1/2 - 20 UNF	1.50	.56	.28	.25	1.00	1.00	0.50	—	.20	—
UF M14 x 1	U14950189	ECO/ECO S 25 MF (B)	M14 x 1,5 (45,0)	(16,0)	(8,0)	(5,0)	(35,0)	(30,0)	(15,0)	—	(5,0)	—	—
UF 9/16 - 18	U19018095	ECO/ECO S 25 IC (B)	9/16 - 18 UNF	1.81	.62	.31	.22	1.38	1.38	—	.19	.32	1.00
UF M14 x 1,5	U13935143	ECO/ECO S 25 MC (B)	M14 x 1,5 (45,0)	(16,0)	(8,0)	(5,0)	(35,0)	(30,0)	(15,0)	—	(5,0)	—	—
UF 3/4 - 16	U120275095	ECO/ECO S 50 (B)	3/4 - 16 UNF	2.00	.62	.31	.25	1.50	1.50	—	.19	.45	1.12
UF M20x 1,5	U12646143	ECO/ECO S 50 MC (B)	M20 x 1,5 (48,0)	(16,0)	(8,0)	(6,5)	(35,0)	(35,0)	(15,0)	—	(4,75)	(10,0)	(25,5)
UF 1-12	U19599095	ECO 100	1-12 UNF	2.00	.62	.31	.25	1.50	1.50	—	.19	.39	(25,5)
UF M25 x 1,5	U13004143	ECO 100/110M	M25 x 1,5 (48,0)	(16,0)	(8,0)	(6,5)	(35,0)	(35,0)	(15,0)	—	(4,75)	(10,0)	(25,5)
UF M27 x 3	U12587143	ECO 100 MC	M27 x 3 (48,0)	(16,0)	(8,0)	(6,5)	(35,0)	(35,0)	(15,0)	—	(4,75)	(10,0)	(25,5)

Notes: 1. Part numbers in page color are non-standard lead time items, contact ITT Enidine.

Non-Adjustable Series

# Non-Adjustable Series Hydraulic Shock Absorbers

## ECO Series

PRO 110 → ECO 225 Series

### Technical Data

### Standard



\*Note: A<sub>1</sub> and E<sub>1</sub> apply to button models and urethane striker cap accessory.

Catalog No./ Model	(S) Stroke in. (mm)	(E <sub>T</sub> ) Max. in.-lbs./cycle (Nm/cycle)	(E <sub>T</sub> E) Emergency Max. in.-lbs./cycle (Nm/cycle)	(F <sub>P</sub> ) (E <sub>T</sub> C) Max. in.-lbs./hour (Nm/h)	(F <sub>D</sub> ) Max. Reaction Force lbs. (N)	Nominal Coil Spring Force		Max. Propelling Force lbs. (N)	Weight (mass) oz. (g)
						Extended lbs. (N)	Compressed lbs. (N)		
PRO 110 IF (B)	1.56 (40,0)	1,700 (190,0)	—	670,000 (75 700)	1,700 (7 500)	4.0 (18,0)	11.0 (49,0)	500 (2 220)	16.0 (454)
PRO 110 MF (B)	(40,0)	(190,0)	—	(75 700)	(7 500)	(18,0)	(49,0)	(2 220)	(454)
PRO 110 MC (B)	(40,0)	(190,0)	—	(75 700)	(7 500)	(18,0)	(49,0)	(2 220)	(454)
ECO 120 IF (B)	1.00 (25,0)	1,640 (185,0)	4,425 (500)	743,500 (84 000)	2,500 (11 120)	12.5 (56,0)	20.0 (89,0)	700 (3 100)	17.0 (482)
ECO 120 MF (B)	(25,0)	(185,0)	(500)	(84 000)	(11 120)	(56,0)	(89,0)	(3 100)	(482)
ECO 125 IF (B)	1.00 (25,0)	1640 (185,0)	4,425 (500)	920,500 (104 000)	2,500 (11 120)	12.5 (56,0)	20.0 (89,0)	700 (3 100)	21.0 (595)
ECO 125 MF (B)	(25,0)	(185,0)	(500)	(104 000)	(11 120)	(56,0)	(89,0)	(3 100)	(595)
ECO 220 IF (B)	2.00 (50,0)	3,100 (350,0)	8,850 (1 000)	911,600 (103 000)	2,500 (11 120)	7.0 (31,0)	20.0 (89,0)	700 (3 100)	23.0 (652)
ECO 220 MF (B)	(50,0)	(350,0)	(1 000)	(103 000)	(11 120)	(31,0)	(89,0)	(3 100)	(652)
ECO 225 IF (B)	2.00 (50,0)	3,100 (350,0)	8,850 (1 000)	1,124,000 (127 000)	2,500 (11 120)	7.0 (31,0)	20.0 (89,0)	700 (3 100)	27.0 (765)
ECO 225 MF (B)	(50,0)	(350,0)	(1 000)	(127 000)	(11 120)	(31,0)	(89,0)	(3 100)	(765)

Notes: \*Maximum energy rating for emergency use only. Estimated cycle life of 1-5 cycles if used at maximum emergency rating.

Catalog No./ Model	Damping Constant	A in. (mm)	A <sub>1</sub> in. (mm)	C in. (mm)	D in. (mm)	E in. (mm)	E <sub>1</sub> in. (mm)	F in. (mm)	J in. (mm)	WF in. (mm)	WL in. (mm)
PRO 110 IF (B)**	-1,-2,-3	7.93	8.06	1-12 UNF	.31	0.88	0.88	5.00	.06	—	—
PRO 110 MF (B)**	-1,-2,-3	(201,4)	(204,7)	(M25 x 1,5)	(8,0)	(22,2)	(22,2)	(127,0)	(1,5)	—	—
PRO 110 MC (B)**	-1,-2,-3	(201,4)	(204,7)	(M25 x 2,0)	(8,0)	(22,2)	(22,2)	(127,0)	(1,5)	—	—
ECO 120 IF (B)	-1,-2,-3	5.52	5.72	1 1/4-12 UNF	.38	1.13	1.20	3.41	.21	1.12	.63
ECO 120MF (B)	-1,-2,-3	(140,2)	(145,3)	M33 x 1,5	(9,5)	(29,0)	(30,5)	(87,0)	(5,3)	(30,0)	(16,0)
ECO 125 IF (B)	-1,-2,-3	5.52	5.72	1 3/8-12 UNF	.38	1.13	1.20	3.41	.21	1.12	.63
ECO 125 MF (B)	-1,-2,-3	(140,2)	(145,3)	M36 x 1,5	(9,5)	(29,0)	(30,5)	(87,0)	(5,3)	(33,0)	(16,0)
ECO 220 IF (B)	-1,-2,-3	8.14	8.34	1 1/4-12 UNF	.38	1.13	1.20	5.03	.21	1.12	.63
ECO 220 MF (B)	-1,-2,-3	(207,0)	(212,0)	M33 x 1,5	(9,5)	(29,0)	(30,5)	(128,0)	(5,3)	(30,0)	(16,0)
ECO 225 IF (B)	-1,-2,-3	8.14	8.34	1 3/8-12 UNF	.38	1.13	1.20	5.03	.21	1.25	.63
ECO 225 MF (B)	-1,-2,-3	(207,0)	(212,0)	M36 x 1,5	(9,5)	(29,0)	(30,5)	(128,0)	(5,3)	(33,0)	(16,0)

Notes: 1. See page 55 for constant damping curves.

\*\*The PRO 110 Model is a Nickel Plated Shock Absorber.

ECO 120 → ECO 225 Series

**Clevis Mount**

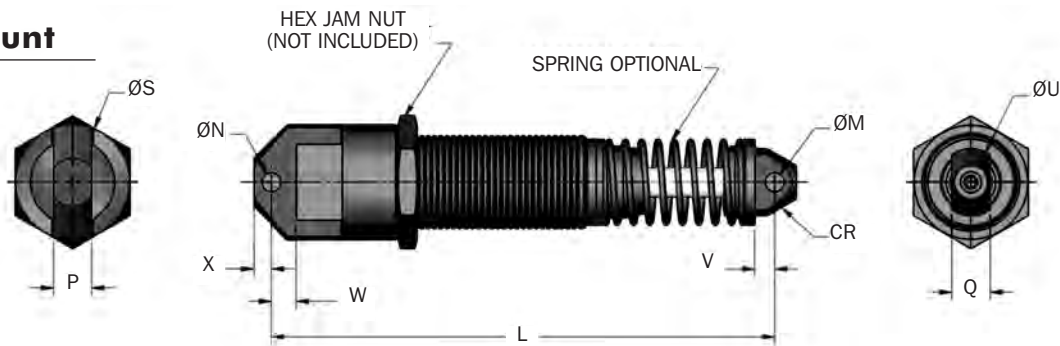

Catalog No./ Model	L in. (mm)	M +.005/- .000 in. (mm)	N +.005/- .000 in. (mm)	P +.000/- .010 in. (mm)	Q +.000/- .010 in. (mm)	S in. (mm)	U in. (mm)	V in. (mm)	W in. (mm)	X in. (mm)	CR in. (mm)	Weight (mass) lbs. (Kg)
ECO 120 CM (S)	6.59 (167)	.251 (6,38)	.251 (6,38)	.500 (12,70)	.500 (12,70)	1.50 (38)	.88 (23)	.23 (6)	.48 (12)	.31 (6,1)	.44 (11,2)	1.3 (0,59)
ECO 220 CM (S)	9.22 (234)	.251 (6,38)	.251 (6,38)	.500 (12,70)	.500 (12,70)	1.50 (38)	.88 (23)	.23 (6)	.48 (12)	.31 (6,1)	.44 (11,2)	1.7 (0,77)
ECO 125 CM (S)	6.59 (180)	.251 (6,38)	.251 (6,38)	.500 (12,70)	.500 (12,70)	1.50 (38)	.88 (22)	.23 (6)	.93 (24)	.23 (6,0)	.44 (11,2)	1.6 (0,73)
ECO 225 CM (S)	9.22 (230)	.251 (6,38)	.251 (6,38)	.500 (12,70)	.500 (12,70)	1.50 (38)	.88 (22)	.23 (6)	.93 (24)	.23 (6,0)	.44 (11,2)	1.9 (0,86)

Notes: 1. (S) indicates model comes with spring.

**Flange Foot Mount**

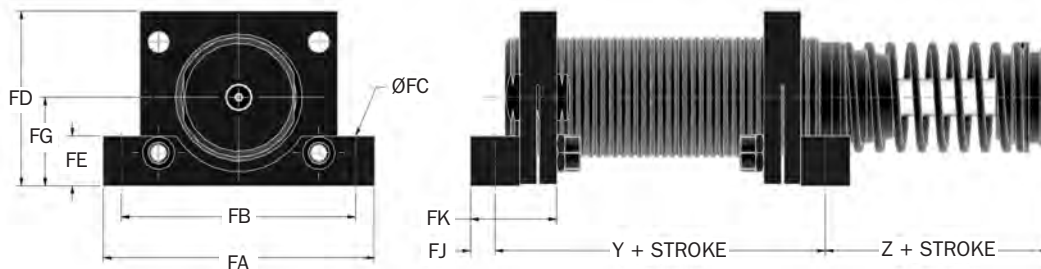

Catalog No./ Model	Part Number	Model (Ref)	Y in. (mm)	Z in. (mm)	FA in. (mm)	FB in. (mm)	FC in. (mm)	FD in. (mm)	FE in. (mm)	FG in. (mm)	FJ in. (mm)	FK in. (mm)	Bolt Size in. (mm)	Kit Weight oz. (g)
FM 1 1/4 - 12	2F21049305	ECO 120/220	2.25	1.25	2.75	2.38	.23	1.77	.50	.90	.25	.88	#10	4.0
FM M33 x 1,5	2F21049306	ECO 120/220M	(57,2)	(31,8)	(70,0)	(60,3)	(5,90)	(45,0)	(12,7)	(22,7)	(6,4)	(22,2)	(M5)	(100)
FM 1 3/8 - 12	2F21293305	ECO 125/225	2.25	1.25	2.75	2.38	.23	1.77	.50	.90	.25	.88	#10	4.0
FM M36 x 1,5	2F21293306	ECO 125/225M	(57,2)	(31,8)	(70,0)	(60,3)	(5,90)	(45,0)	(12,7)	(22,7)	(6,4)	(22,2)	(M5)	(100)

Notes: 1. Shock absorber must be ordered separately from foot mount kit.  
2. All foot mount kits include two foot mounts.

# Non-Adjustable Series Hydraulic Shock Absorbers

## ECO Series

ECO 120 → ECO 225 Series

Accessories

### Stop Collar (SC)

Non-Adjustable Series

#### Imperial

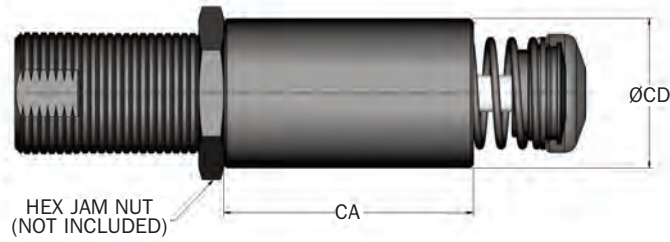

#### Metric



Catalog No./ Model	Part Number	Model (Ref)	CA in. (mm)	CD in. (mm)	WF in. (mm)	WL in. (mm)	Weight (mass) oz. (g)
SC 1 1/4-12	M921049057	ECO 120/220	2.50	1.50	–	–	7.0
SC M33 x 1,5	M930290171	ECO 120/220 M	(41,0)	(38,0)	(36,0)	(17,0)	(210)
SC 1 3/8-12	M921293057	ECO 120/220	2.50	1.69	–	–	7.0
SC M36 x 1,5	M930285058	ECO 120/220 M	(63,5)	(43,0)	(41,0)	(18,0)	(210)

### Jam Nut (JN)

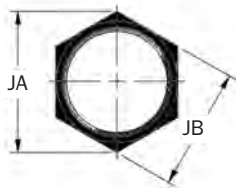

Catalog No./ Model	Part Number	Model (Ref)	JA in. (mm)	JB in. (mm)	JH in. (mm)	Weight (mass) oz. (g)
JN 1 1/4-12	J18609034	ECO 120/220	1.73	1.50	.25	0.9
JN M33 x 1,5	J28609035	ECO 120/220 M	(47,3)	(41,0)	(6,4)	(27)
JN 1 3/8-12	J13164034	ECO 125/225	1.73	1.50	.25	0.9
JN M36 x 1,5	J23164034	ECO 125/225 M	(47,3)	(41,0)	(6,4)	(27)



ECO 120 → ECO 225 Series

**Urethane Striker Cap (USC)**

Non-Adjustable Series

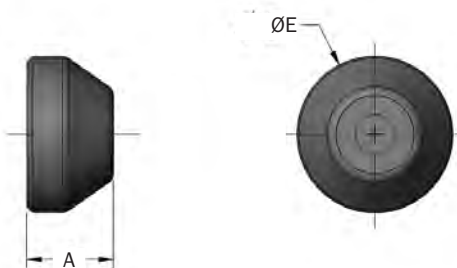

Catalog No./ Model	Part Number	Model (Ref)	A in. (mm)	E <sub>1</sub> in. (mm)	Weight (mass) oz. (g)
UC 8609	C98609079	ECO 120, 125, 220 & 225	.39 (10,0)	1.20 (30,5)	0.1 (3)

**Rectangular Flange (RF)**

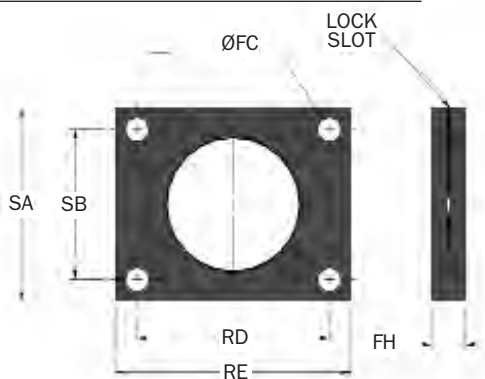

Catalog No./ Model	Part Number	Model (Ref)	FC in. (mm)	FH in. (mm)	RD in. (mm)	RE in. (mm)	SA in. (mm)	SB in. (mm)	Bolt Size in. (mm)	Wt. (mass) oz. (g)
RF 1 1/4 - 12	N121049129	ECO 120/220	.22	.38	1.63	2.00	1.75	1.13	#10	1.0
RF M33 x 1,5	N121049141	ECO 120/ 220M	(5,5)	(9,5)	(41,3)	(50,8)	(44,5)	(28,6)	(M5)	(30)
RF 1 1/4 - 12	N121293129	ECO 125/225	.22	.38	1.63	2.00	1.75	1.13	#10	1.0
RF M36 x 1,5	N121293141	ECO 125/225M	(5,5)	(9,5)	(41,3)	(58,8)	(44,5)	(28,6)	(M5)	(30)

# Non-Adjustable Series Hydraulic Shock Absorbers

ECO 8 → ECO S50 Series

## Sizing Curves

Non-Adjustable Series

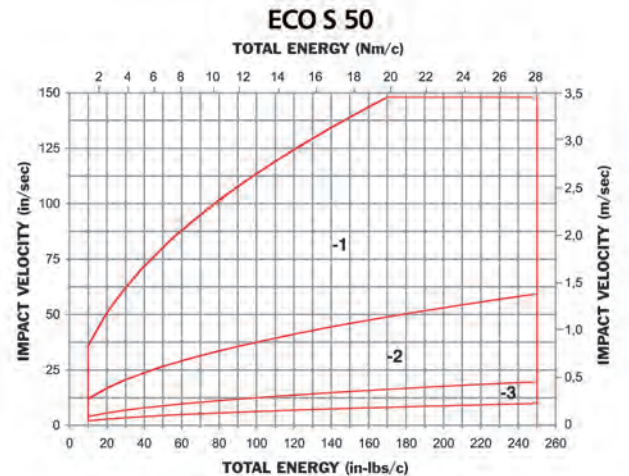
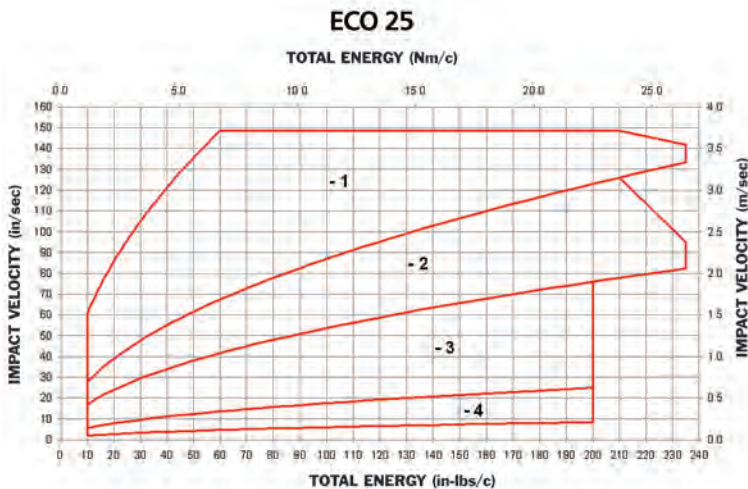
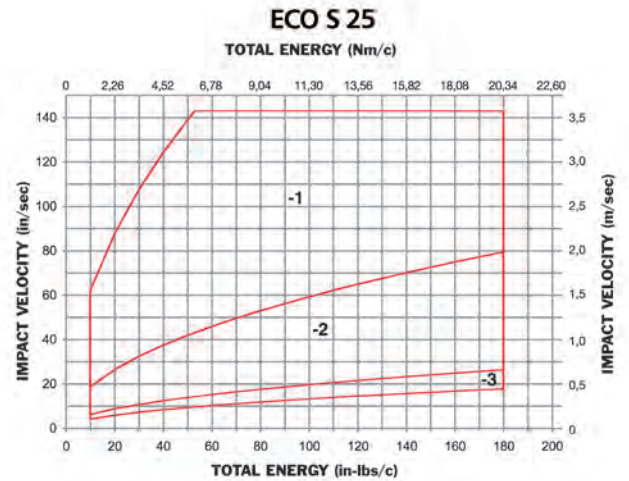
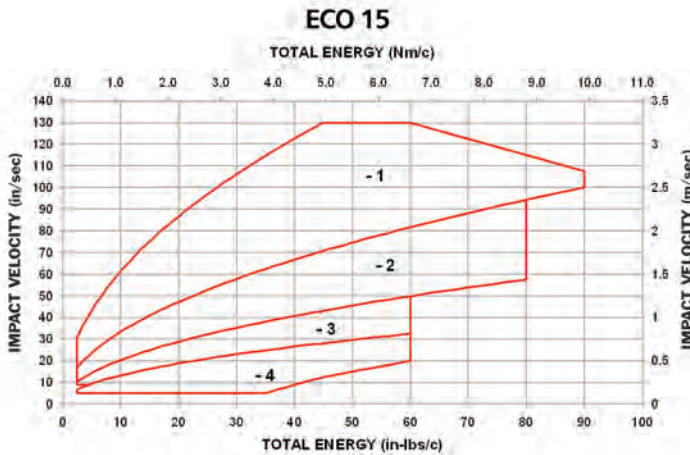
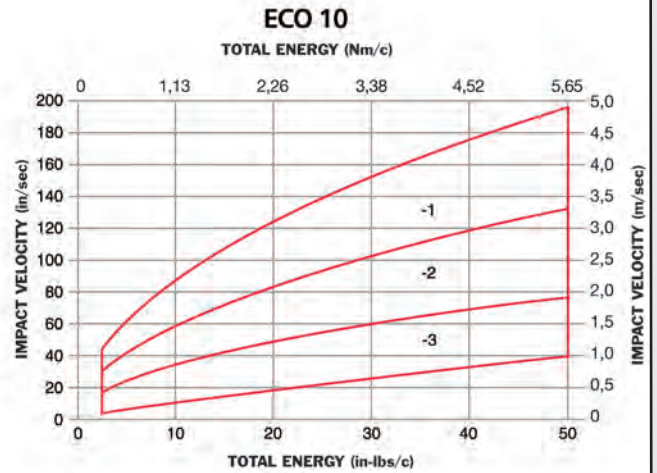
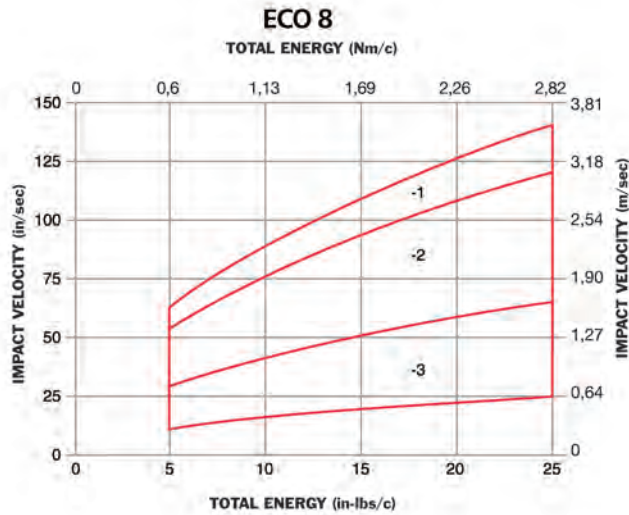

Note: Minimum impact velocity for ECO models is 4 in./sec. (0,1 m/sec).

ECO 50 → ECO 225 Series

Non-Adjustable Series

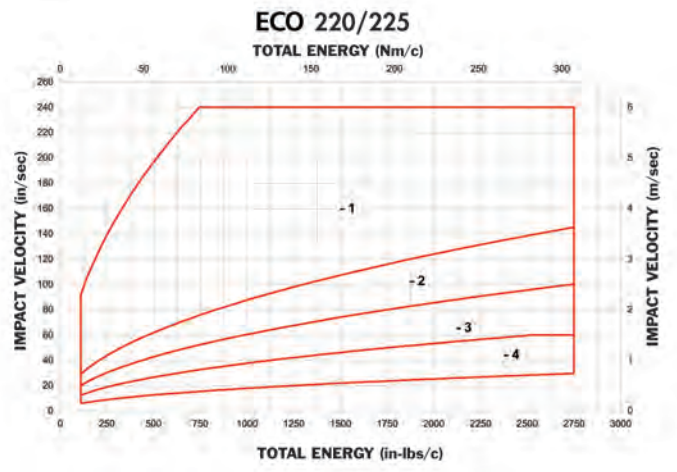
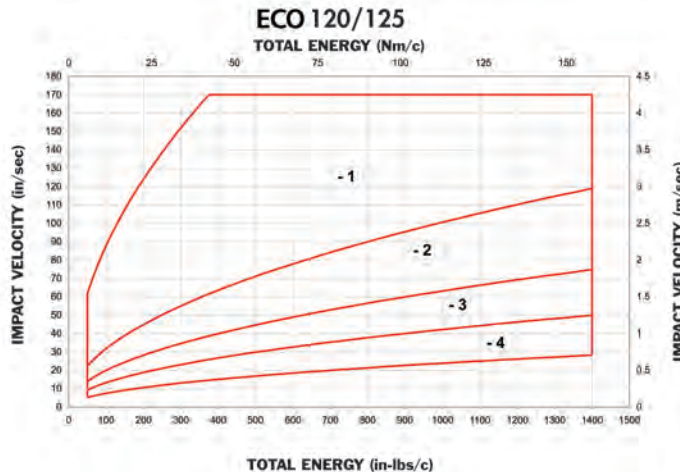
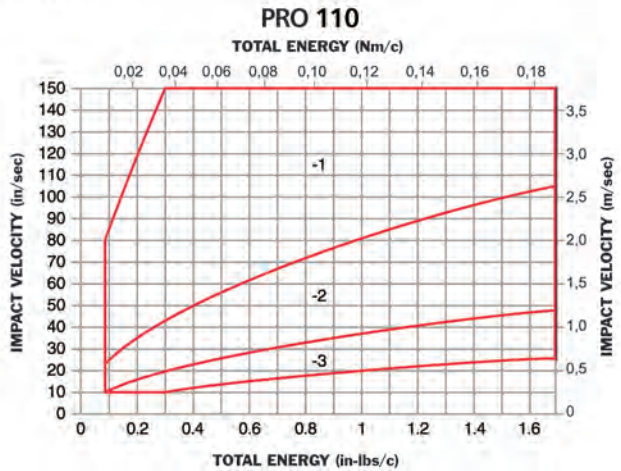
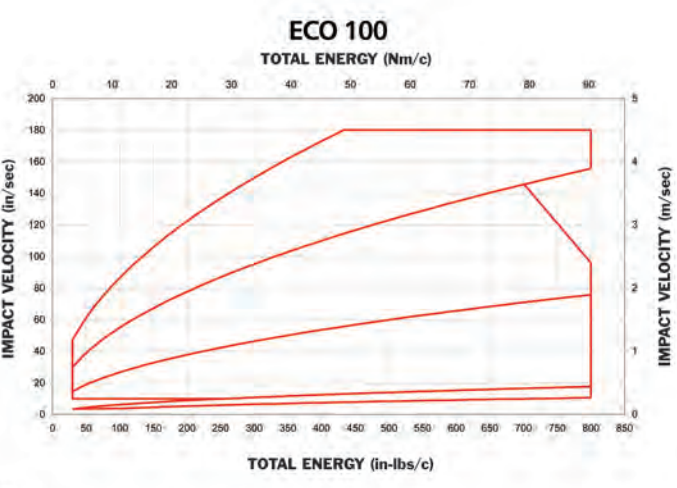
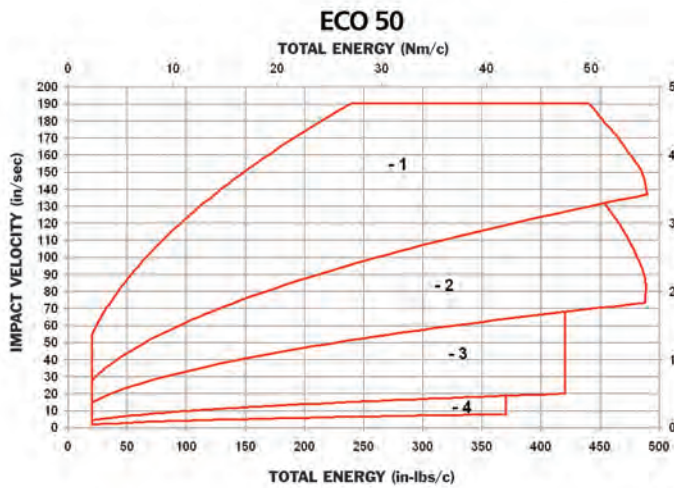

Note: Minimum impact velocity for PRO and ECO models is 4 in./sec. (0,1 m/sec).

### Typical Applications

Non-Adjustable Series



Factory Automation

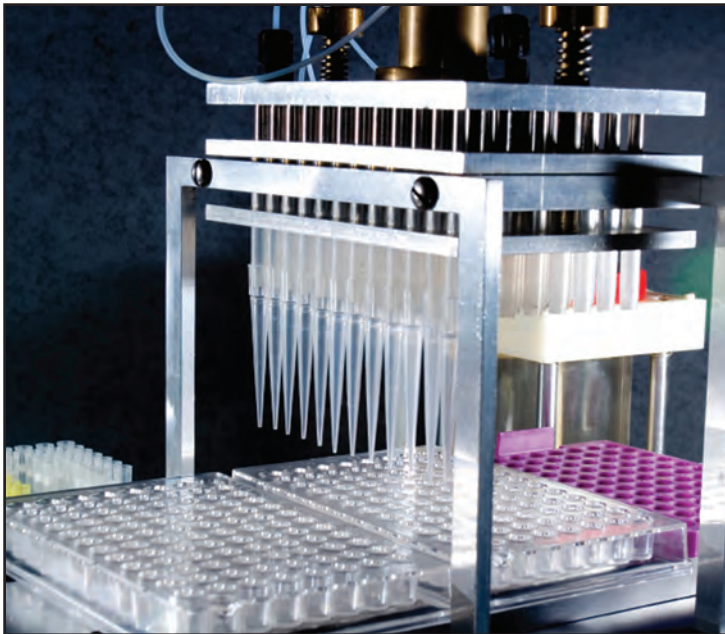

Medical Laboratory Equipment



Food Processing