

GU LINE



Innesti Rapidi
Couplings
Coupleurs
Kupplungen



Innesto rapido DN7,4

Coupler DN7,4

Coupleur DN7,4

Kupplung DN7,4

GU 26

1	2	3	4	5	
Corpo Body Corps Körper	Otturatore Valve Clapet Ventil	Molle Springs Ressorts Feder	Guarnizioni Seals Joint d'étanchéité Dichtung	Sfere Balls Billes Kugel	Innesti Plugs Embouts Stecker
Ottone UNI EN 12164 CW614N Nichelato Brass UNI EN 12164 CW614N Nickel plated Laiton UNI EN 12164 CW614N Nickelé Ms Vernickelt UNI EN 12164 CW614N	Ottone UNI EN 12164 CW614N Nichelato Brass UNI EN 12164 CW614N Nickel plated Laiton UNI EN 12164 CW614N Nickelé Ms Vernickelt UNI EN 12164 CW614N	Acciaio Inox AISI 302 Stainless Steel AISI 302 Acier Inox AISI 302 Edelstahl AISI 302	NBR NBR NBR NBR	Acciaio Inox AISI 420 Stainless Steel AISI 420 Acier Inox AISI 420 Edelstahl AISI 420	Ottone UNI EN 12164 CW614N Nichelato Brass UNI EN 12164 CW614N Nickel plated Laiton UNI EN 12164 CW614N Nickelé Ms Vernickelt UNI EN 12164 CW614N



-20°C ÷ 80°C



0 ÷ 15 bar



7,4 mm



1400 NI/min
(6 bar - Δp = 1bar)



SILICONEFREE



RoHS



REACH





Profilo Europeo
European Profile
Profil européen
Europäisches Profil

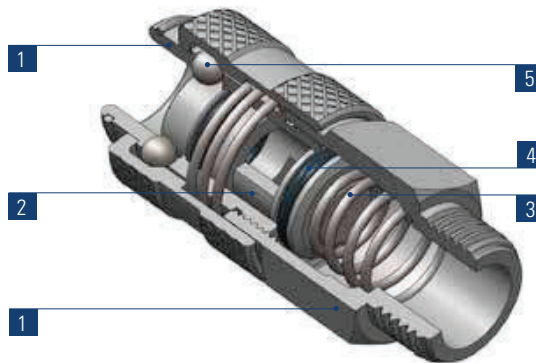

Campi di applicazione:
Impianti pneumatici.

Application fields:
Pneumatic circuits.

Domaines d'application:
Circuits pneumatiques.

Anwendungsbereiche:
Pneumatische Anlagen.

GU 26-11

Innesto rapido con filetto maschio

Male coupling

Coupleur mâle

Einschraubkupplung

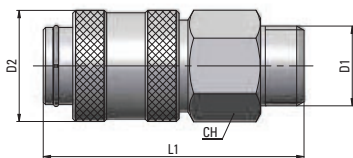

Tipo	D1	D2	L1	CH	g ΔΔ
11 00 14	G1/4	23	54	19	82
11 00 38	G3/8	23	54	20	89
11 00 12	G1/2	23	54	24	107

GU 26-12

Innesto rapido con filetto femmina

Female coupling

Coupleur femelle

Aufschraubkupplung

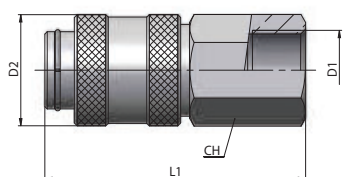

Tipo	D1	D2	L1	CH	g ΔΔ
12 00 14	G1/4	23	54	19	91
12 00 38	G3/8	23	54	20	90,5
12 00 12	G1/2	23	54	24	105

GU 26-13

Innesto rapido con portagomma

Coupling with hose connection

Coupleur avec douille cannelée

Kupplung mit Schlauchtülle

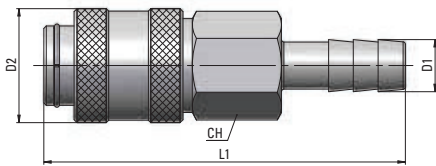

Tipo	Øi Tubo	D1	D2	L1	CH	g $\Delta\Delta$
13 06 00	6	7,5	23	73	19	89
13 09 00	9	10,5	23	73	19	91
13 13 00	13	14,5	23	73	19	94

GU 26-15

Innesto rapido con calzamento

Coupling with Nut fitting

Coupleur avec raccord à écrou

Kupplung mit Überwurfverschraubung

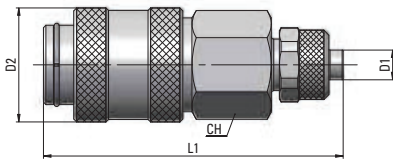

Tipo	D1	D2	L1	CH	g $\Delta\Delta$
15 08 00	8x6	23	60	19	89
15 10 00	10x8	23	61	19	103

GU 26-20

Innesto con filetto maschio

Male plug

Embout mâle

Einschraubverschußnippel

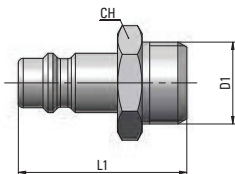

Tipo	D1	L1	CH	g $\Delta\Delta$
20 00 14	G1/4	33	17	22
20 00 38	G3/8	34	20	30
20 00 12	G1/2	37	24	50

GU 26-21

Innesto con filetto femmina

Female plug

Embout femelle

Aufschraubverschußnippel

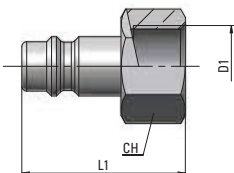

Tipo	D1	L1	CH	g $\Delta\Delta$
21 00 14	G1/4	33	17	24
21 00 38	G3/8	33	20	25
21 00 12	G1/2	36	24	40

GU 26-22

Innesto con portagomma

Plug with hose connection

Embout avec douille cannelée

Schlauchtülle

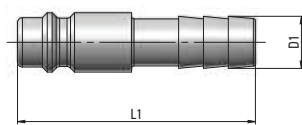

Tipo	Øi Tubo	D1	L1	g $\Delta\Delta$
22 06 00	6	7,5	48	15
22 08 00	8	9,5	48	16
22 09 00	9	10,5	48	17
22 10 00	10	11,5	48	21
22 13 00	13	14,5	48	34

GU 26-23

Innesto con raccordo a calzamento

Plug with Nut Fitting

Embout avec raccord à écrou

Verschußtülle mit Überwurfmutter

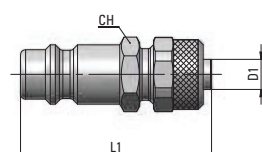

Tipo	D1	L1	CH	g $\Delta\Delta$
23 06 00	6x4	38	13	20
23 08 00	8x6	39	13	21
23 10 00	10x8	42	15	29

GU 26-24

Innesto con molla di protezione

Plug with hose protection spring

Embout avec ressort protection tube

Verschlussstülle mit Knickschutzfeder

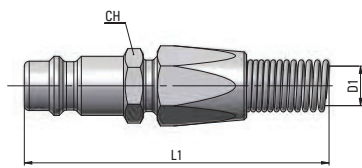

Tipo	D1	L1	CH	g Δ
24 06 00	6x4	120	13	30
24 08 00	8x6	125	13	34
24 10 00	10x8	135	15	52,5